

SAVANT LIGHTING

The Next Generation of Lighting Control

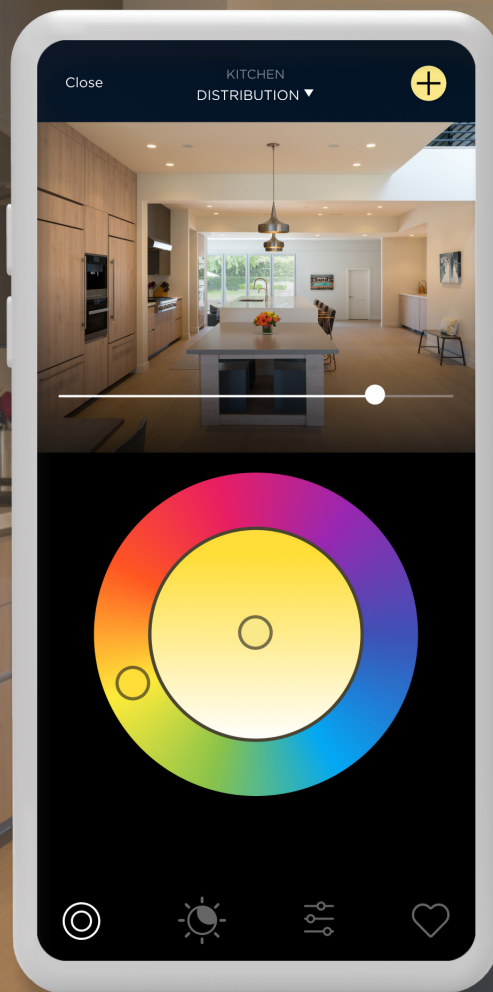

SAVANT

savant.com/lighting

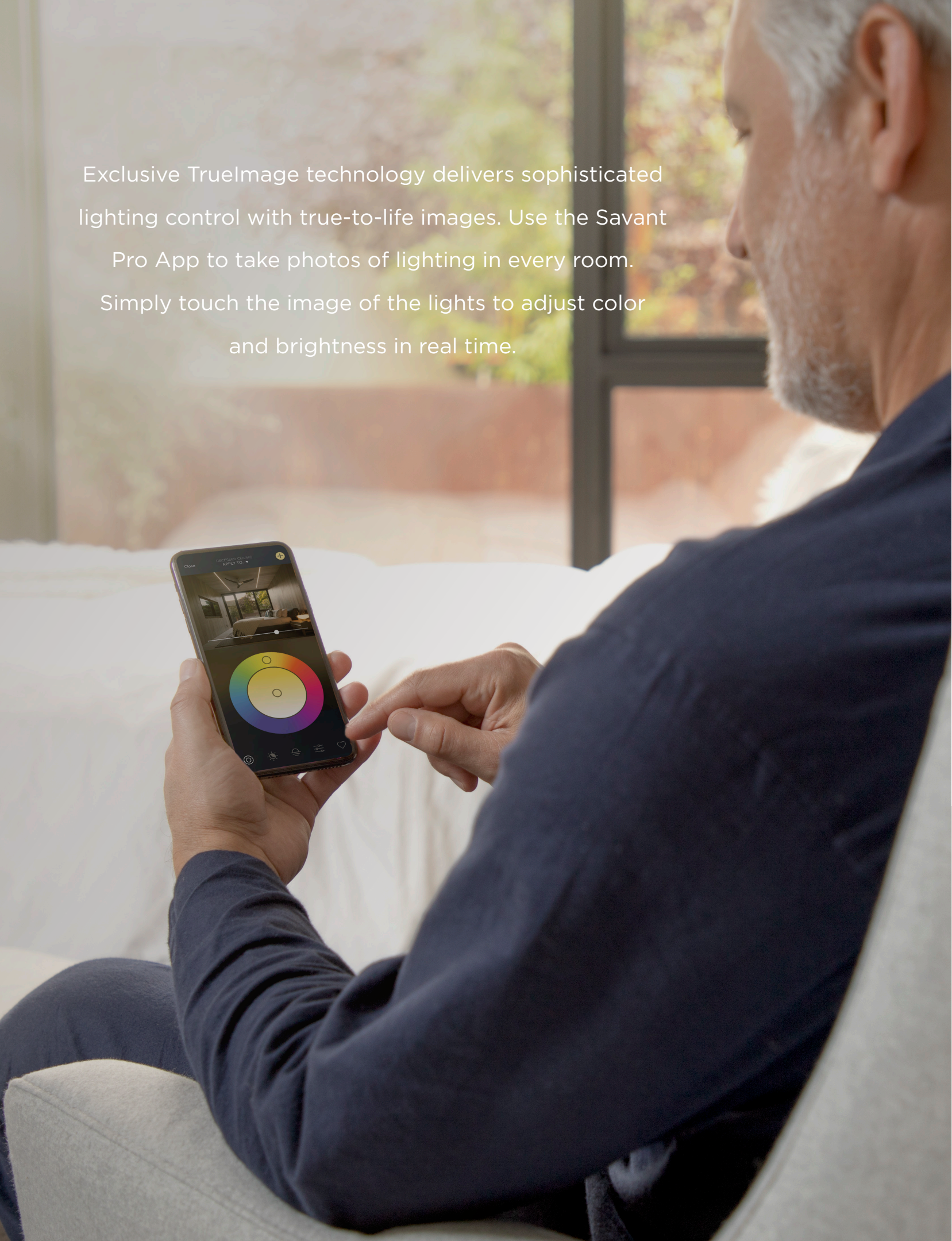

Exclusive TrueImage technology delivers sophisticated lighting control with true-to-life images. Use the Savant Pro App to take photos of lighting in every room. Simply touch the image of the lights to adjust color and brightness in real time.

TAKE CHARGE WITH TRUEIMAGE

For a personal and intuitive experience use photos to control the lights throughout your home.

Tap on the **Image** of the light to toggle it on and off.

Tap on the **Sliders** to access **WRGB** control of your lights, which allow for extremely detailed color selection.

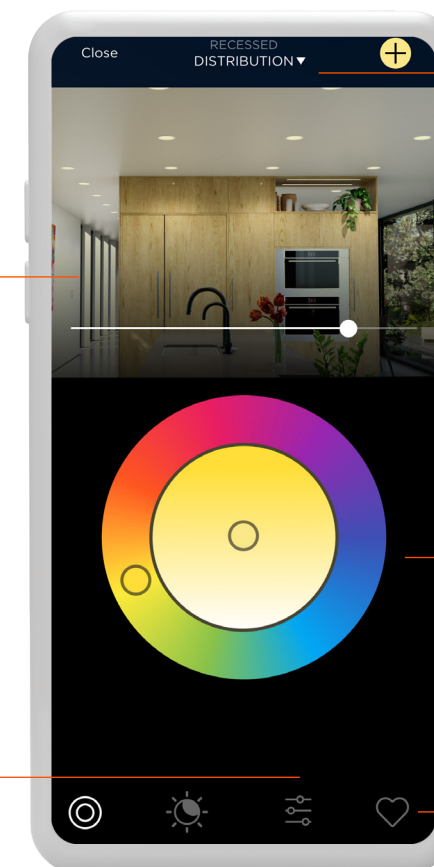

Tap on **Distribution** to send the selected color and brightness to other lights in your home.

Light and enhance every room with a near infinite range of colors.

Tap on **Favorites** to access a list of your most used colors.

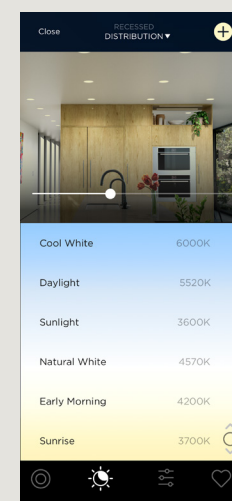

Whites

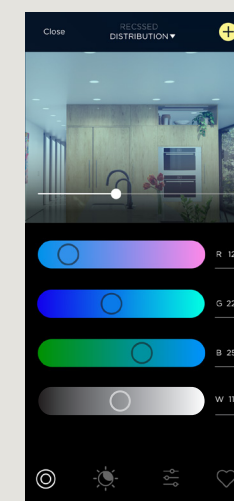

WRGB Sliders

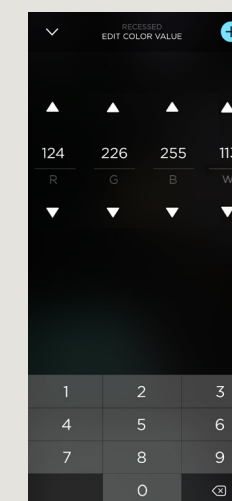

WRGB Input

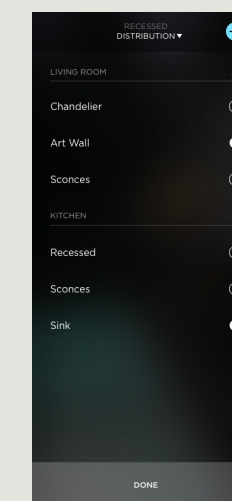

Distribution

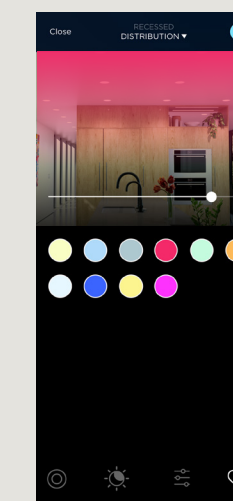

Favorites

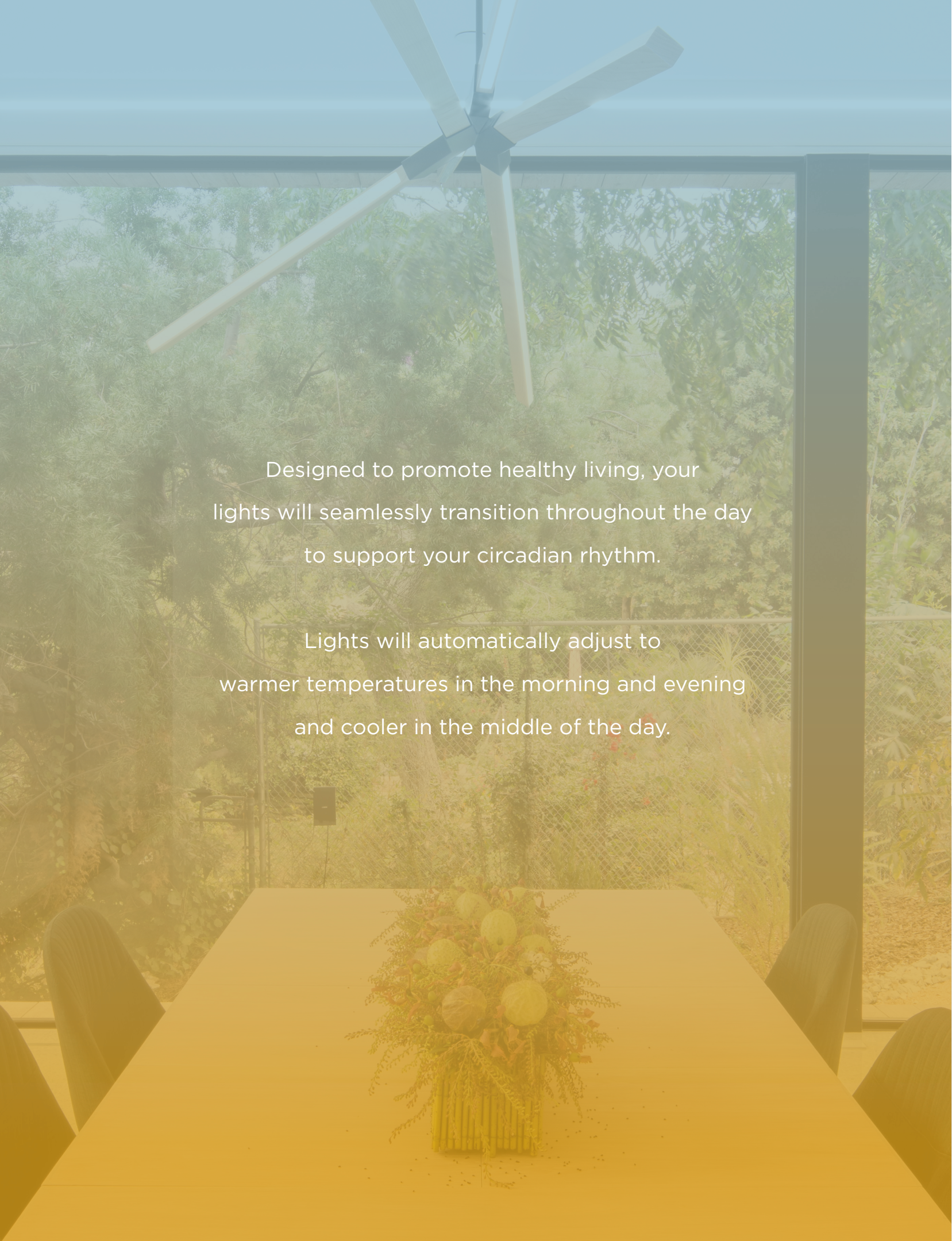

Designed to promote healthy living, your lights will seamlessly transition throughout the day to support your circadian rhythm.

Lights will automatically adjust to warmer temperatures in the morning and evening and cooler in the middle of the day.

A PERSONALIZED WELLNESS EXPERIENCE

Designed to promote healthy living, Daylight Mode enables your lights to seamlessly transition throughout the day to support your circadian rhythm.

Select from scientific defaults, or personalize the lighting experience suit your daily habits

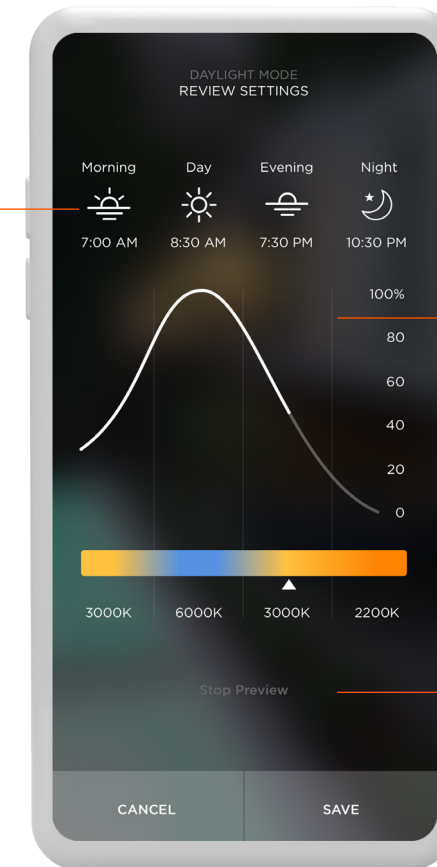

Independently adjust timing, color temperature and intensity for bright white light during the day and warmer tones in the evening hours

After all adjustments are made, activate the **Preview Mode** to experience your 24-hour circadian settings in just 60 seconds

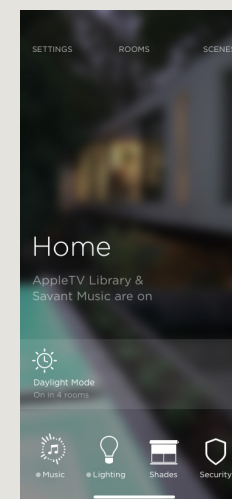

Mode Status

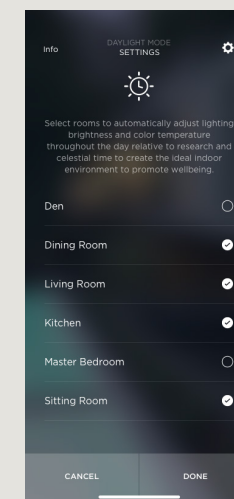

Room Selection

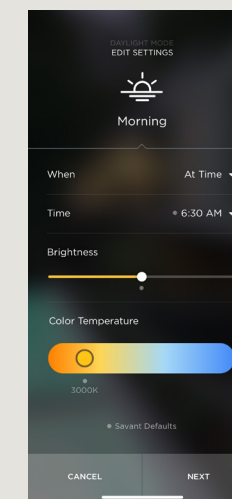

Personalization

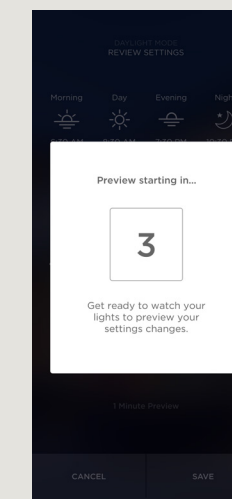

Start Preview

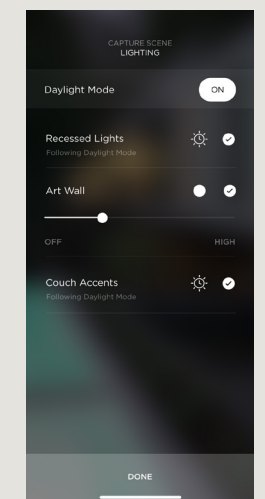

Circadian Scenes

A SCENE FOR EVERY MOMENT

Scenes are handy app settings that put saved lighting routines at your fingertips for easy recall: wake-up, arrival, bedtime, and more.

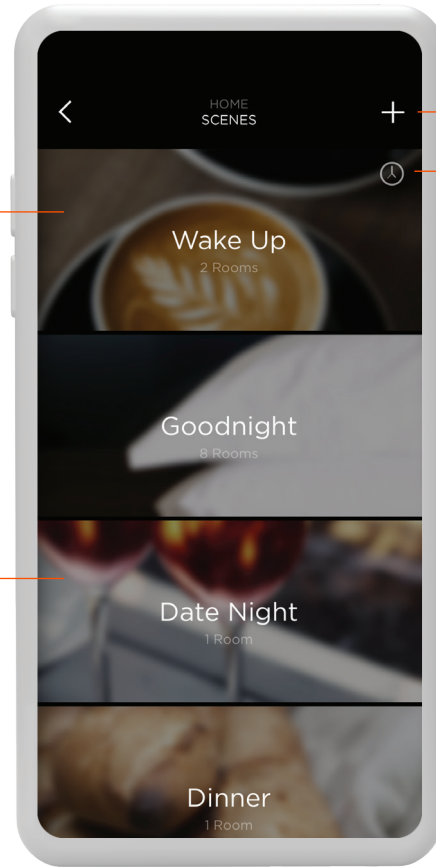

Create instant ambiance with a touch using captured scenes.

Custom scenes can be unique to each user or **Shared**.

Tap on **+** to create a new scene.

Create **Schedules** for your lights based on exact time, dawn, sunrise, sunset or dusk.

SCENES ON A BUTTON

Create a favorite scene in the Savant Pro App and assign it to a button on an Ascend, Echo or Metropolitan Keypad.



Assign your Scenes to a button on an Ascend, Echo or Metropolitan Keypad directly from the Savant Pro App.

Create the Scene you want or use a pre-existing one, then choose which button to assign it to in your Savant Pro App.

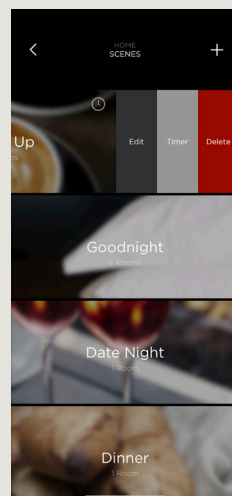

Edit Scenes

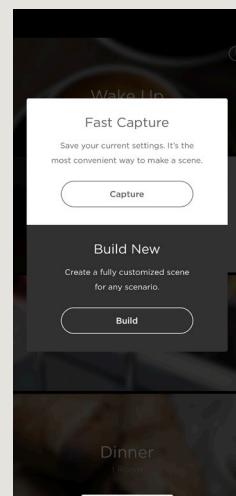

Create New Scene

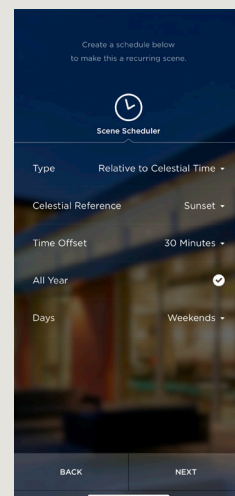

Scene Timer

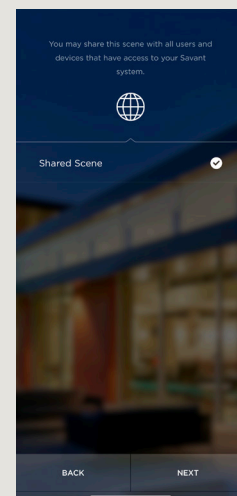

Shared Scene

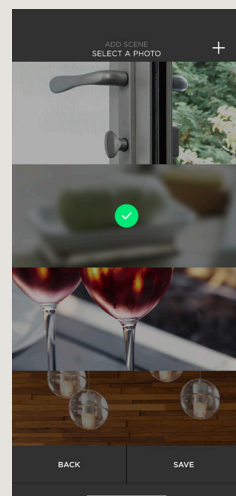

Custom Image

UNMATCHED CONTROL

Be in complete control of your lighting with interface options including keypads, wall switches, touchscreens, remotes or voice commands.

Stay in control of your lighting remotely with a built-in secure remote connection to your home from the Savant Pro App.

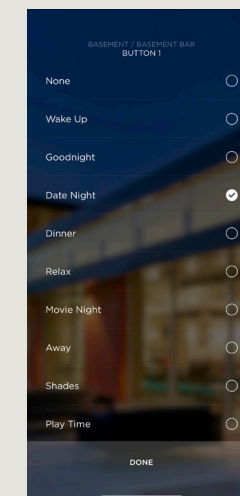

Choose a Scene

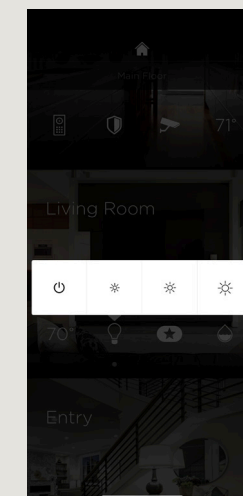

Quick Controls

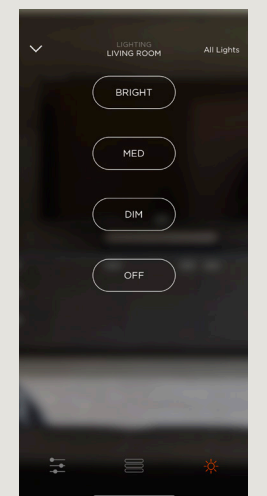

Brightness

SEAMLESS WHOLE HOME CONTROL WITH SAVANT'S FLEXIBLE SYSTEM ARCHITECTURE

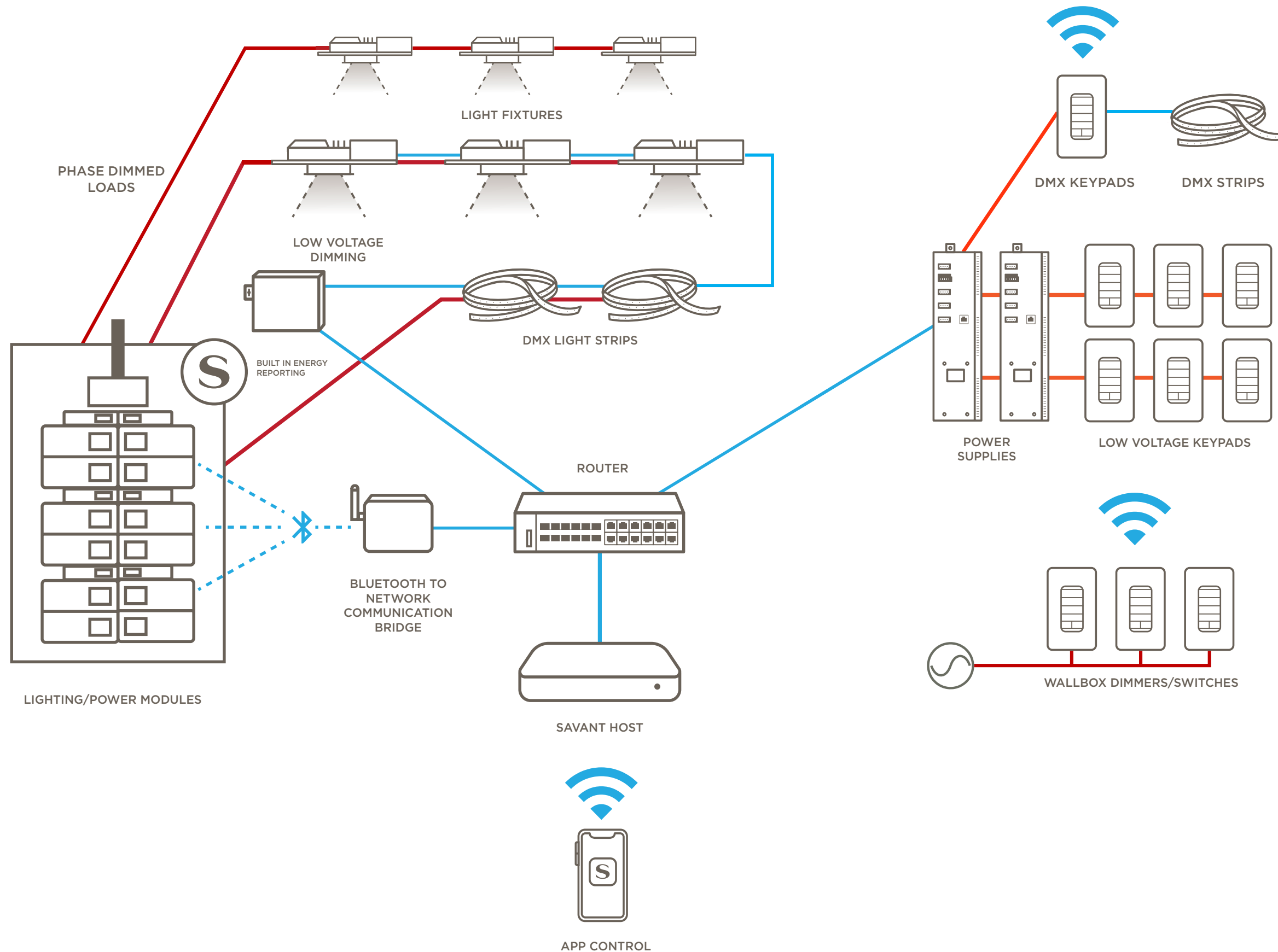

SIMPLIFIED INSTALLATION

Savant's Lighting and Power Modules are designed to be installed into standard electrical panels, eliminating the need for large, costly proprietary panels.

THE PANEL BRIDGE CONTROLLER

Eliminates all low voltage wiring inside the panel simplifying installation and local inspection.

MORE THAN TRADITIONAL LIGHTING CONTROL

Savant Power Systems are designed with a foundation built on the standard electrical panel, making installation quick and easy. Each module delivers precision lighting and load control, as well as revenue-grade energy monitoring at the circuit level. All while consuming minimal space thus keeping utility rooms and spaces efficient.

Connect large appliances, outlets, pool pumps and other electrical loads up to 60 Amps to one of Savant's relay modules and deliver energy consumption data across the whole home.

LIGHTING FIXTURES

Pair USAI Lighting fixtures with a Savant lighting control system for an enhanced lifestyle including WRGB color selection plus the choice of a range of Kelvin temperature settings that synchronize seamlessly with your daily routine.

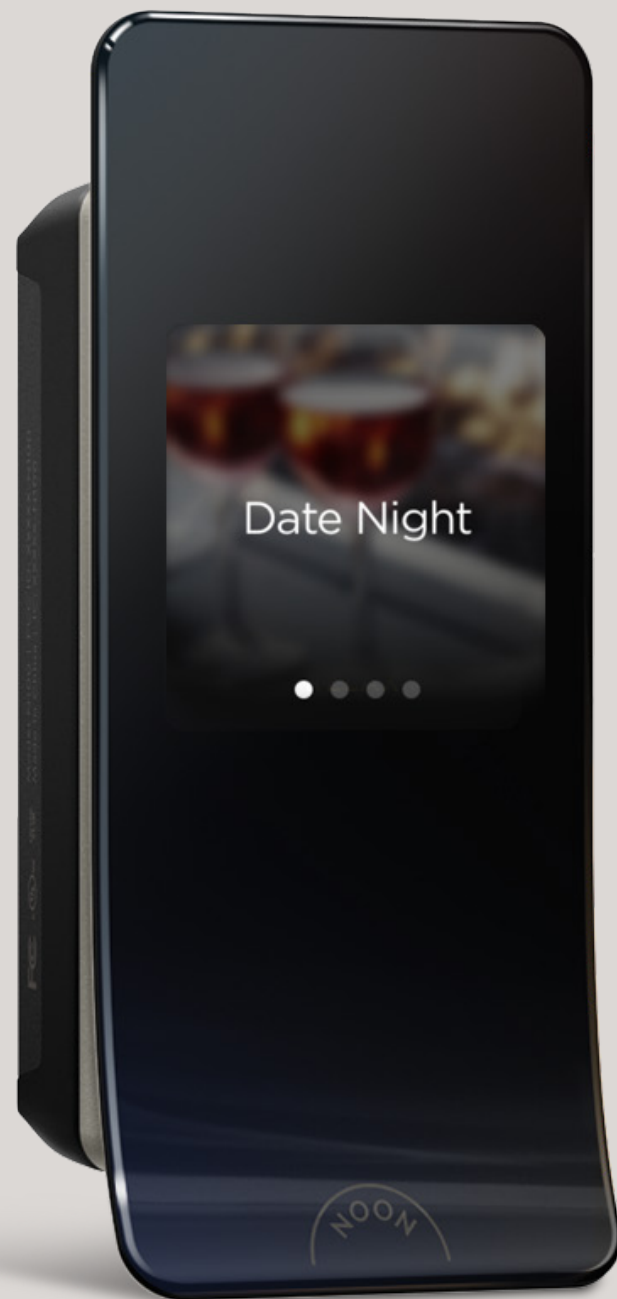

NOON LINE VOLTAGE KEYPAD

Enhance everyday lighting with NOON's scene-based system. Award-winning, modern design and precision dimming makes a carefully-designed room look its best. NOON uses algorithms to detect bulb types and apply the perfect dimming curves to ensure no flicker or buzz.

BUTTON CONFIGURATIONS



NOON DIRECTOR



NOON DIMMER



NOON SWITCH



FACEPLATE FINISH

SATIN

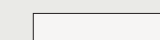

SW Satin White

LED COLOR



White

POWER

120V AC

WATTAGE

See Specification Sheets for load dimming capacities

COMMUNICATION

- BLE Communication between devices.
- Touch Keypad communicates directly with the Savant System

FACEPLATE OPTIONS

NOON offers screwless faceplates from 1 - 4 gang

KEY FEATURES

- Control up to 10 NOON Dimmers or Switches for every Director
- Glass touch screen with OLED display on Director
- One-touch control of room and whole-home scenes
- Control from anywhere
- Universal dimmer (INC/HAL, LED, ELV, MLV)
- 120V, requires neutral and ground wire
- Single pole, 3-way and 4-way
- WiFi and Bluetooth Low Energy



ASCEND LOW VOLTAGE KEYPAD

Ascend Low Voltage Keypads are available in 3 different button configurations and 9 finishes. These high-end keypads are designed to be easily read from standing height. Backlit engraving can be set to one of 9 different colors.

BUTTON CONFIGURATIONS



BRUSHED BRASS



BRUSHED ALUMINUM

2 BUTTON



SNOW WHITE

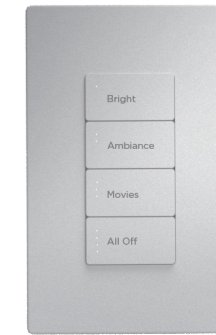

NICKEL

4 BUTTON



BRUSHED BRONZE



BRUSHED ALUMINUM



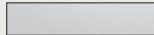
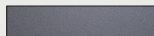

5 BUTTON

FINISH

ANODIZED / BEAD BLASTED

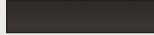
-  BK Black
-  NK Nickel
-  SG Space Gray

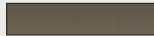
BRUSHED

-  BB Brushed Black
-  BR Brushed Brass
-  BZ Brushed Bronze
-  AL Brushed Aluminium

PAINTED

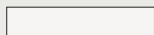
-  SW Snow White
-  LA Light Almond

LED COLOR

- | | | |
|--|--|---|
|  Yellow |  Teal |  Caution Orange |
|  Clover Green |  Indigo |  Hot Pink |
|  Echo Blue |  Fire Red |  White |

POWER

24V DC

COMMUNICATION

Wired

FACEPLATE OPTIONS

Integrated with Keypad /
Savant offers screwless
faceplates from 1 - 4 gangs

KEY FEATURES

- **Savant Control** - More than just lighting, buttons can control audio, video, shades, climate and more, plus Scenes created in the Savant Pro App can also be saved to a button



ECHO LOW VOLTAGE KEYPAD

Echo Low Voltage Keypads are available in 10 different button configurations and three finishes. They are designed to be easily read from standing height and backlit engraving can be set to one of 9 different colors.

BUTTON CONFIGURATIONS



CONFIGURABLE
KEYPAD: 3 BUTTON

CONFIGURABLE
KEYPAD: 3 BUTTON

CONFIGURABLE
KEYPAD: 4 BUTTON



CONFIGURABLE
KEYPAD: 4 BUTTON

CONFIGURABLE
KEYPAD: 5 BUTTON

CONFIGURABLE
KEYPAD: 5 BUTTON



CONFIGURABLE
KEYPAD: 5 BUTTON

CONFIGURABLE
KEYPAD: 6 BUTTON



DIAL KEYPAD:
4 BUTTON

PADDLE KEYPAD:
2 BUTTON

FINISH

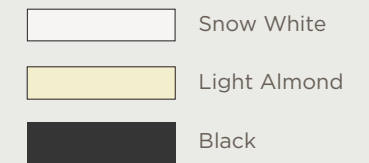

LED COLOR



POWER

24V DC

COMMUNICATION

- Wired- 4-Conductor

FACEPLATE OPTIONS

Savant offers screwless faceplates from 1 - 4 gangs

KEY FEATURES

- **Traditional sized opening** - matching faceplates available, or add your own decorative faceplate
- **Ambient light sensor** - Button LEDs dim or brighten based on the amount of light in the room
- **Savant Control** - More than just lighting, buttons can control audio, video, shades, climate and more, plus Scenes created in the Savant Pro App can also be saved to a button
- **Expandable** - Support for up to 32 loads with S2 Hosts, 64 loads with Smart Hosts and unlimited load count with the Pro and Super Pro Hosts



ECHO LINE VOLTAGE KEYPAD

Echo Style Line Voltage Keypads are available with multiple, field configurable options plus our classic, intuitive dial for dimming or volume control.

BUTTON CONFIGURATIONS



CONFIGURABLE
KEYPAD: 3 BUTTON

CONFIGURABLE
KEYPAD: 3 BUTTON

CONFIGURABLE
KEYPAD: 4 BUTTON



CONFIGURABLE
KEYPAD: 4 BUTTON

CONFIGURABLE
KEYPAD: 5 BUTTON

CONFIGURABLE
KEYPAD: 5 BUTTON



CONFIGURABLE
KEYPAD: 5 BUTTON

CONFIGURABLE
KEYPAD: 6 BUTTON

DIAL KEYPAD:
4 BUTTON



FAN
CONTROL

PADDLE KEYPAD:
2 BUTTON

AUXILIARY
CONTROL

Configurable and Paddle keypads are available with adaptive dimming, forward phase (MLV) dimming and switching

FINISH

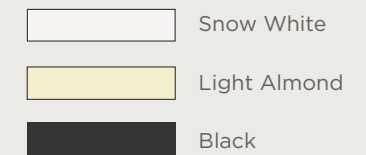

LED COLOR



POWER

120V AC

WATTAGE

See Specification Sheets for load dimming capacities

COMMUNICATION

Wireless

CONTROL

- Adaptive Dimming
- Forward Phase (MLV) Dimming
- Switch
- Auxiliary
- Fan Control

FACEPLATE OPTIONS

Savant offers screwless faceplates from 1 - 4 gangs

KEY FEATURES

- **Traditional sized opening** - matching faceplates available, or add your own decorative faceplate
- **Ambient light sensor** - Button LEDs dim or brighten based on the amount of light in the room
- **Savant Control** - More than just lighting, buttons can control audio, video, shades, climate and more, plus Scenes created in the Savant Pro App can also be saved to a button
- **Expandable** - Support for up to 32 loads with S2 Hosts, 64 loads with Smart Hosts and unlimited load count with the Pro and Super Pro Hosts



METROPOLITAN LOW VOLTAGE KEYPAD

Metropolitan Style Line Voltage Keypads are available with multiple options plus our classic, intuitive dial for dimming or volume control.

BUTTON CONFIGURATIONS



DIAL KEYPAD:
4 BUTTON



SWITCH



CONFIGURABLE
KEYPAD: 4 BUTTON





AUXILIARY
CONTROL

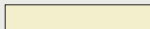

CONFIGURABLE
KEYPAD: 6 BUTTON

FINISH

-  Snow White
-  Light Almond
-  Black

LED COLOR

-  Yellow
-  Teal
-  Caution Orange
-  Clover Green
-  Indigo
-  Hot Pink
-  Echo Blue
-  Fire Red
-  White

POWER

24V DC

COMMUNICATION

- Wired- 4-Conductor

FACEPLATE OPTIONS

Savant offers screwless faceplates from 1 - 4 gangs

KEY FEATURES

- **Traditional sized opening** - matching faceplates available, or add your own decorative faceplate
- **Ambient light sensor** - Button LEDs dim or brighten based on the amount of light in the room
- **Savant Control** - More than just lighting, buttons can control audio, video, shades, climate and more, plus Scenes created in the Savant Pro App can also be saved to a button
- **Expandable** - Support for up to 32 loads with S2 Hosts, 64 loads with Smart Hosts and unlimited load count with the Pro and Super Pro Hosts



METROPOLITAN LINE VOLTAGE KEYPAD

Metropolitan Style Line Voltage Keypads are available with multiple options plus our classic, intuitive dial for dimming or volume control.

BUTTON CONFIGURATIONS



DIAL KEYPAD:
4 BUTTON



SWITCH



Configurable Keypad:
4 Button





AUXILIARY
CONTROL

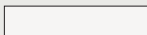
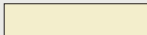

Configurable Keypad:
6 Button

FINISH

-  Snow White
-  Light Almond
-  Black

LED COLOR

-  Yellow
-  Teal
-  Caution Orange
-  Clover Green
-  Indigo
-  Hot Pink
-  Echo Blue
-  Fire Red
-  White

POWER

120V AC

WATTAGE

See Specification Sheets for load dimming capacities

COMMUNICATION

Wireless

CONTROL

- Adaptive Dimming
- Forward Phase (MLV) Dimming
- Switch
- Auxiliary
- Fan Control

FACEPLATE OPTIONS

Savant offers screwless faceplates from 1 - 4 gangs

KEY FEATURES

- **Traditional sized opening** - matching faceplates available, or add your own decorative faceplate
- **Ambient light sensor** - Button LEDs dim or brighten based on the amount of light in the room
- **Savant Control** - More than just lighting, buttons can control audio, video, shades, climate and more, plus Scenes created in the Savant Pro App can also be saved to a button
- **Expandable** - Support for up to 32 loads with S2 Hosts, 64 loads with Smart Hosts and unlimited load count with the Pro and Super Pro Hosts

LIGHTING AND POWER MODULES

DUAL ADAPTIVE PHASE DIMMER

Designed for use with a variety of loads, with control capability for dimming two loads up to 500 VA. Automatically reports energy usage into the Savant Pro App for flexible load management. Compatible with either QO or Homeline style electrical panels.



DUAL FORWARD PHASE DIMMER

Designed for use with loads that require forward phase dimming including Magnetic Low Voltage. Control capability for dimming two loads up to 300 VA or a single load at 600VA. Automatically reports energy usage into the Savant Pro App for flexible load management. Compatible with either QO or Homeline style electrical panels.



DUAL RELAY 20 AMP

The Dual Relay 20 Amp Module is designed to control two 120V circuit loads, and can readily switch two 20A loads independently including lighting, plug loads or any other electrical appliance up to 20 Amps. Automatically reports energy usage into the Savant Pro App for flexible load management. Compatible with either QO or Homeline style electrical panels.



SINGLE RELAY 240V 30 AMP

The Single Relay 240V 30 Amp Module is designed to control a single 240V circuit load, and can readily switch a single 30 Amp load for large appliances. Automatically reports energy usage into the Savant Pro App for flexible load management. Compatible with either QO or Homeline style electrical panels.



SINGLE NC-NO CONTROL RELAY

The single NC/NO Control Relay companion module is designed to control one Square D™ Powerlink™ Remote controlled circuit breaker. This relay module is an essential building-block within the Savant critical load management architecture. It can dynamically switch critical and non-critical loads on / off based upon previously set parameters. Compatible with QO style electrical panels.



LOW VOLTAGE CONTROLLERS

Savant's DMX Low Voltage Controllers allow for use of USAI Lighting's Infinite Color+ fixtures and Savant's pro grade light strips. Utilizing RDM setup could not be easier, which allows the controller to automatically discover all of the fixtures or strips on the channel.

KEY FEATURES

- Support for up to 32 fixtures or strips
- RDM support
- RJ45 DMX Connection (Wired Controller)
- Terminal Strip DMX/Power Connection (Wireless Keypad)

WIRED DMX CONTROLLER



WIRELESS CONFIGURABLE KEYPAD WITH DMX CONTROL

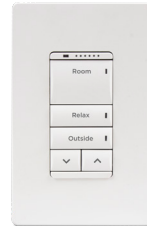

POWER SUPPLIES AND ACCESSORIES

10 KEYPAD POWER AND CONTROL MODULE

Provides wired power and communication for up to 10 Savant Low Voltage Keypads making it a great solution for smaller projects.



WIRED 0-10V LOW VOLTAGE CONTROLLER

Savant's stand alone 0-10V Low Voltage Controllers pair perfectly with USAI Lighting fixtures allowing for both intensity control, as well as dual output options for Tunable White. 0-10V lighting provides superior dimming to traditional phase dimming using more traditional wiring.

KEY FEATURES

- 8 Outputs, up to 64 fixtures or a maximum of 8 fixtures per output
- Note that a max of 32 USAI Lighting color select, tunable white fixtures per controller

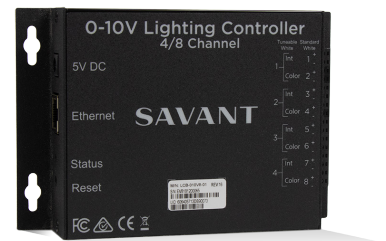

40 KEYPAD POWER AND CONTROL MODULE

LOW VOLTAGE POWER MODULE ENCLOSURE

Provides wired power and communication for up to 40 Savant Low Voltage Keypads. The keypad power and control module is designed to be installed inside the Low Voltage Power Module Enclosure. Up to 3 modules can be installed into the power module enclosure or can be mixed with Savant 5 Shade Power Modules.



PANEL BRIDGE CONTROLLER

The Savant Panel Bridge acts as the primary interface between Savant Lighting and Energy Modules and the system's network. Each Panel Bridge communicates with up to 40 modules.

LAMP CONTROL

Convenient wireless control of lamps, and switched loads. Works with both Echo and Metropolitan interfaces.





SAVANT PRO

Savant lighting control products automatically report real-time, utility-grade energy information to the Savant Pro App. Homeowners can use this information to dynamically manage energy usage throughout the home.

SAVANT POWER SYSTEM

In addition to sophisticated lighting control features including Truelmage, WRGB color settings and Daylight Mode, the Savant Pro App provides real-time, utility grade energy information.

Savant Power Systems deliver visibility to energy production and consumption trends, help you weather a power outage, as well as help you offset peak utility rates when on the grid and optimize your energy usage when off the grid.



ENERGY MODES

MONITORING

HISTORY

SAVANT

savant.com

© 2022 Savant Systems, Inc. All rights reserved.